

ADL 餐台轨系列

餐台钢珠滑轨 35MM MULTI-SECTION LIGHT DUTY DINING TABLE SLIDE



餐台轨系列
DINING TABLE SLIDE SERIES



ZN

ADL-3503-N-1-TB-4-or-1130-B

BK

ADL3503 轻型多节导轨

承重能力：50kg

材料：1.5mm冷板、1.5mm镀锌板

表面处理：电镀锌层、电泳

颜色：白色、黑色

包装：10套/箱(不含螺丝)

Load rating：50kg

Material：1.5mm cold-roll sheet / 1.5mm zinc plated sheet

Finish：Clear zinc plated / electrophoresis

Color：White / Black

Package：10 set / carton(without screw)

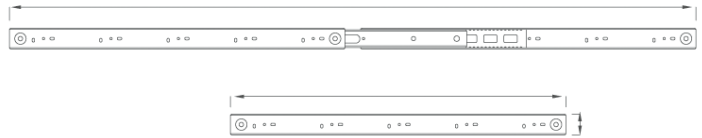

A主轨长度(mm) A Track Length(mm)	B副轨长度(mm) B Track Length(mm)	C中间距离(mm) C Middle distance(mm)	D拉开总长度(mm) D Total length(mm)
550	550	580	1130

35MM SINGLE EXTENSION DINING TABLE SLIDE



ZN

ADL-3501-N-1-TB-4-or--700-B

BK

ADL3501 轻型单拉导轨

承重能力：50kg

材料：1.5mm冷板、1.5mm镀锌板

表面处理：电镀锌层、电泳

颜色：白色、黑色

包装：10套/箱(不含螺丝)

Load rating：50kg

Material：1.5mm cold-roll sheet / 1.5mm zinc plated sheet

Finish：Clear zinc plated / electrophoresis

Color：White / Black

Package：10 set / carton(without screw)

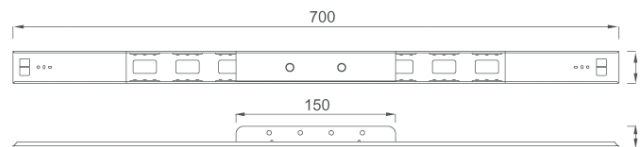

A主轨长度(mm) A Track Length(mm)	B副轨长度(mm) B Track Length(mm)	C中间距离(mm) C Middle distance(mm)	D拉开总长度(mm) D Total length(mm)
700	150	550	700

ADL 餐台轨系列

餐台钢珠滑轨 35MM LIGHT DUTY DINING TABLE SLIDE WITHOUT IRON WIRE



澳德里

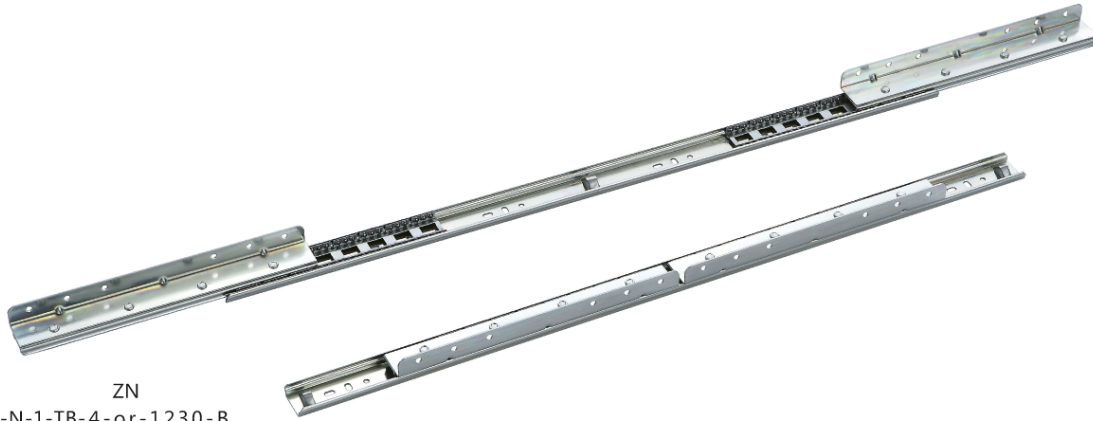

ZN
ADL-3502-N-1-TB-4-or-1230-B
BK

ADL3502 轻型餐台导轨(不带钢丝)

承重能力: 50kg

材料: 1.5mm冷板、1.5mm镀锌板

表面处理: 电镀锌层、电泳

颜色: 白色、黑色

包装: 10套/箱(不含螺丝)

Load rating: 50kg

Material: 1.5mm cold-roll sheet / 1.5mm zinc plated sheet

Finish: Clear zinc plated / electrophoresis

Color: White / Black

Package: 10 set / carton(without screw)

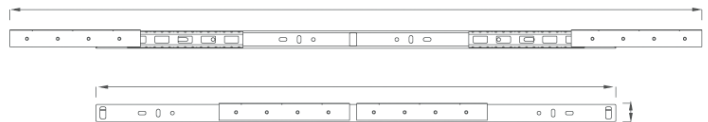

A主轨长度(mm) A Track Length(mm)	B副轨长度(mm) B Track Length(mm)	C中间距离(mm) C Middle distance(mm)	D拉开总长度(mm) D Total length(mm)
700	260	530	1230

35MM H-TYPE DINING TABLE SLIDE WITHOUT IRON WIRE



980
ADL-3500-N-1-TB-4-ZN--↓--B
1400

ADL35 H型自动升降导轨

承重能力: 50kg

材料: 1.5mm冷板、1.5mm镀锌板

表面处理: 电镀

颜色: 白色

包装: 6套/箱(不含螺丝)

Load rating: 50kg

Material: 1.5mm cold-roll sheet /
1.5mm zinc plated sheet

Finish: electrophoresis

Color: White

Package: 6 set / carton(without screw)

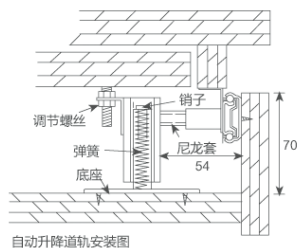

自动升降道轨安装图

导轨总长(mm) Guide rail length	升降架长度(mm) Lifting frame length	升降宽度(mm) Lifting width(mm)	升降高度(mm) Lifting height(mm)
980	610	300	20-30
1100	610	300	20-30
1130	660	350	20-30
1200	660	350	20-30
1300	710	400	20-30
1400	760	450	20-30

DINING TABLE SLIDE SERIES
餐台轨系列

ADL 餐台轨系列

餐台钢珠滑轨 35MM LIGHT-DUTY DINING TABLE SLIDE



餐台轨系列
DINNING TABLE SLIDE SERIES



ZN 820

ADL-3502A-N-1-TB-4-or--↓--B

BK 1050

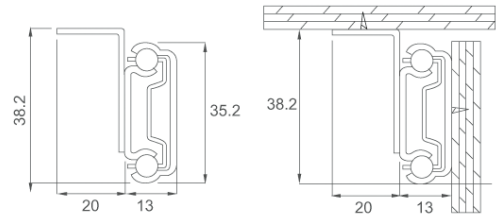

ADL3502 轻型餐台走珠导轨

承重能力:50kg

材料:1.5mm冷板、1.5mm镀锌板

表面处理:电镀锌层、电泳

颜色:白色、黑色

包装:10套/箱(不含螺丝)

Load rating:50kg

Material:1.5mm cold-roll sheet / 1.5mm zinc plated sheet

Finish:Clear zinc plated / electrophoresis

Color:White / Black

Package:10 set / carton(without screw)

导轨总长(mm) Guide rail length	升降架长度(mm) Lifting frame length	升降宽度(mm) Lifting width(mm)	升降高度(mm) Lifting height(mm)
600	235	350	820
650	235	350	820
700	250	350	850
750	300	400	1000
800	300	450	1050

35MM LIGHT-DUTY DINING TABLE SLIDE

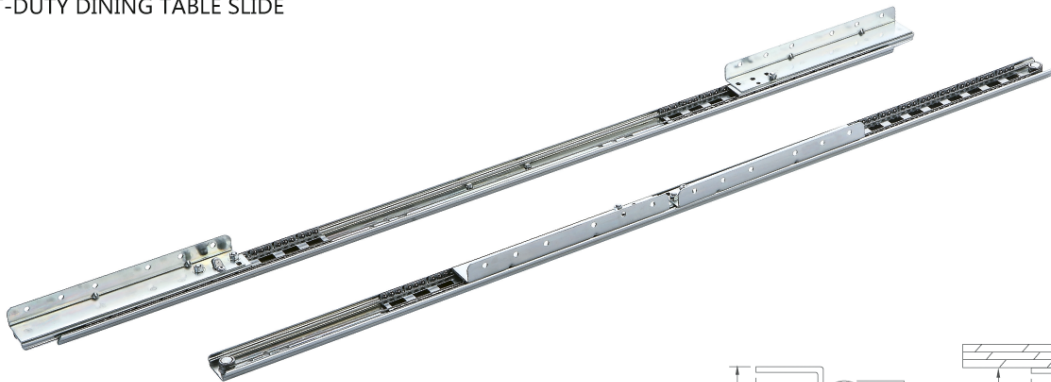

ZN 820

ADL-3502B-N-1-TB-4-or--↓--B

BK 1050

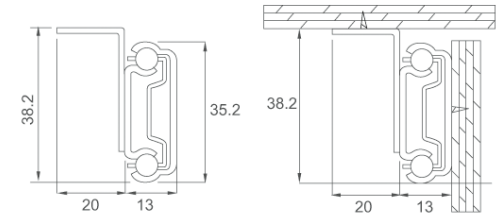

ADL3502B 轻型餐台走珠导轨

承重能力:50kg

材料:1.5mm冷板、1.5mm镀锌板

表面处理:电镀锌层、电泳

颜色:白色、黑色

包装:10套/箱(不含螺丝)

Load rating:50kg

Material:1.5mm cold-roll sheet / 1.5mm zinc plated sheet

Finish:Clear zinc plated / electrophoresis

Color:White / Black

Package:10 set / carton(without screw)

导轨总长(mm) Guide rail length	升降架长度(mm) Lifting frame length	升降宽度(mm) Lifting width(mm)	升降高度(mm) Lifting height(mm)
600	235	350	820
650	235	350	820
700	250	350	850
750	300	400	1000
800	300	450	1050

ADL 餐台轨系列

餐台钢珠滑轨

48MM HEAVY-DUTY DOUBLE-STANDARD SECTION
FOLDING DINING TABLE SLIDE



澳德里



ADL-4803A-S-1-TB-4-ZN-1595-B

ADL4803 重型多节导轨

承重能力:60kg Load rating:60kg
 材料:2mm冷板、2mm镀锌板 Material:2mm cold-roll sheet / 2mm zinc plated sheet
 表面处理:电镀锌层、电泳 Finish:Clear zinc plated / electrophoresis
 颜色:白色 Color:White
 包装:4套/箱(不含螺丝) Package:4 set / carton(without screw)

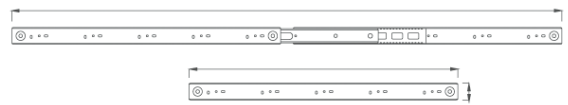

A主轨长度(mm) A Track Length(mm)	B副轨长度(mm) B Track Length(mm)	C中间距离(mm) C Middle distance(mm)	D拉开总长度(mm) D Total length(mm)
685	685	910	1595

48MM HEAVY-DUTY SINGLE EXTENSION DINING TABLE SLIDE

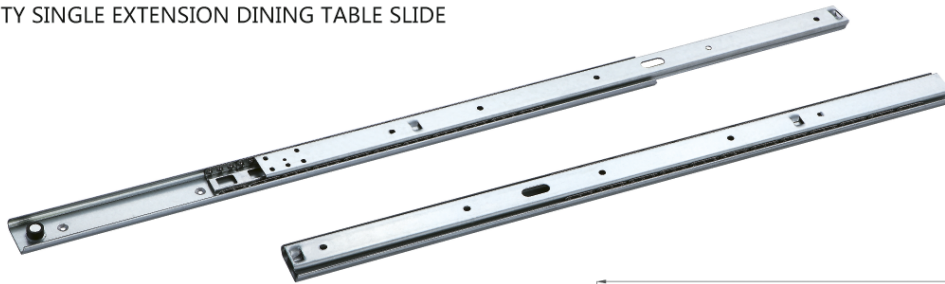

ADL-4801-S-1-TB-4-ZN-1390-B

ADL4801 重型单导轨

承重能力:60kg Load rating:60kg
 材料:2mm冷板、2mm镀锌板 Material:2mm cold-roll sheet / 2mm zinc plated sheet
 表面处理:电镀锌层、电泳 Finish:Clear zinc plated / electrophoresis
 颜色:白色 Color:White
 包装:4套/箱(不含螺丝) Package:4 set / carton(without screw)



A主轨长度(mm) A Track Length(mm)	B副轨长度(mm) B Track Length(mm)	C中间距离(mm) C Middle distance(mm)	D拉开总长度(mm) D Total length(mm)
750	750	640	1390

48MM DOUBLE STACK DINING TABLE SLIDE WITH "L" BRACKET



ADL-4803B-S-1-TB-4-ZN-2500-B

ADL4803 双重导轨(铁片)

承重能力:60kg Load rating:60kg
 材料:2mm冷板、2mm镀锌板 Material:2mm cold-roll sheet / 2mm zinc plated sheet
 表面处理:电镀锌层、电泳 Finish:Clear zinc plated / electrophoresis
 颜色:白色 Color:White
 包装:4套/箱(不含螺丝) Package:4 set / carton(without screw)

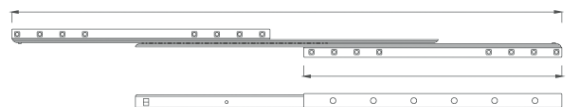

A主轨长度(mm) A Track Length(mm)	B副轨长度(mm) B Track Length(mm)	C中间距离(mm) C Middle distance(mm)	D拉开总长度(mm) D Total length(mm)
1300	1300	1200	2500

DINING TABLE SLIDE SERIES
餐台轨系列

ADL 餐台轨系列

餐台钢珠滑轨 48MM DOUBLE STACK DINING TABLE SLIDE



餐台轨系列
DINING TABLE SLIDE SERIES

ADL-4803C-S-1-TB-4-ZN-2360-B

ADL4803 双叠导轨(带角码)

承重能力:60kg

材料:2mm冷板、2mm镀锌板

表面处理:电镀锌层、电泳

颜色:白色

包装:4套/箱(不含螺丝)

Load rating:60kg

Material:2mm cold-roll sheet / 2mm zinc plated sheet

Finish:Clear zinc plated / electrophoresis

Color:White

Package:4 set / carton(without screw)

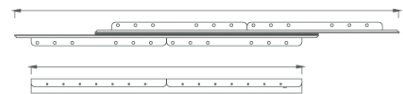
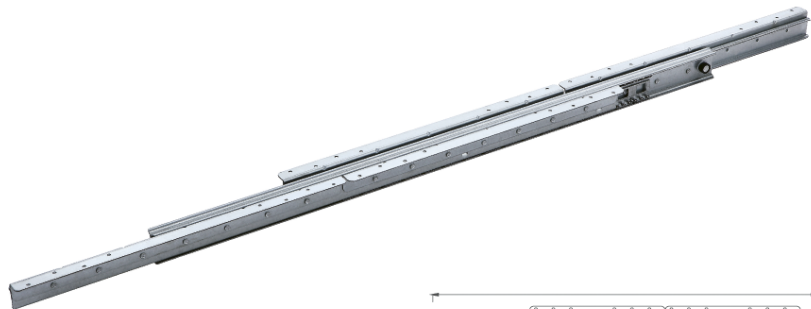

A主轨长度(mm) A Track Length(mm)	B副轨长度(mm) B Track Length(mm)	C中间距离(mm) C Middle distance(mm)	D拉开总长度(mm) D Total length(mm)
1000	1000	1360	2360

48MM HEAVY-DUTY CONCEALED BOTTOM MOUNT STAIRCASE CABINET SLIDE

1040

ADL-4802A-S-1-TB-4-ZN-1040-B

2340

ADL4802A 重型餐台走珠导轨

承重能力:60kg

材料:2mm冷板、2mm镀锌板

表面处理:电镀锌层、电泳

颜色:白色

包装:4套/箱(不含螺丝)

Load rating:60kg

Material:2mm cold-roll sheet /
2mm zinc plated sheet

Finish:Clear zinc plated / electrophoresis

Color:White

Package:4 set / carton(without screw)

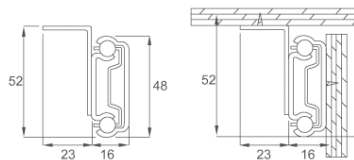
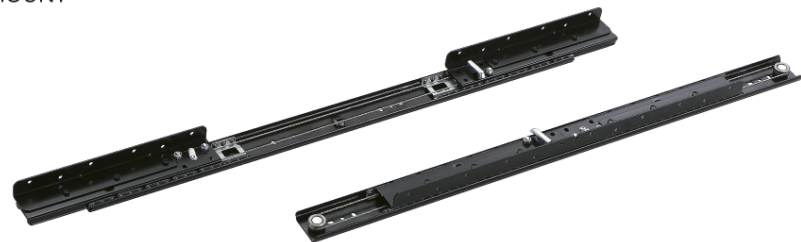

A主轨长度(mm) A Track Length(mm)	B副轨长度(mm) B Track Length(mm)	C中间距离(mm) C Middle distance(mm)	D拉开总长度(mm) D Total length(mm)
800	300	440	1040
850	330	490	1150
900	350	540	1240
950	350	590	1290
1000	400	640	1440
1100	400	740	1540
1200	450	840	1740
1300	500	940	1930
1400	550	1040	2140
1500	600	1140	2340

48MM HEAVY-DUTY CONCEALED BOTTOM MOUNT STAIRCASE CABINET SLIDE

1040

ADL-4802B-S-1-TB-4-ZN-1040-L

2340

ADL4802B 重型餐台走珠导轨

承重能力:60kg

材料:2mm冷板、2mm镀锌板

表面处理:电镀锌层、电泳

颜色:白色

包装:4套/箱(不含螺丝)

Load rating:60kg

Material:2mm cold-roll sheet /
2mm zinc plated sheet

Finish:Clear zinc plated / electrophoresis

Color:White

Package:4 set / carton(without screw)

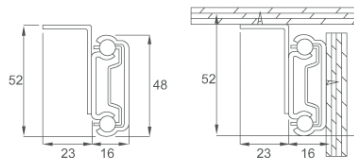
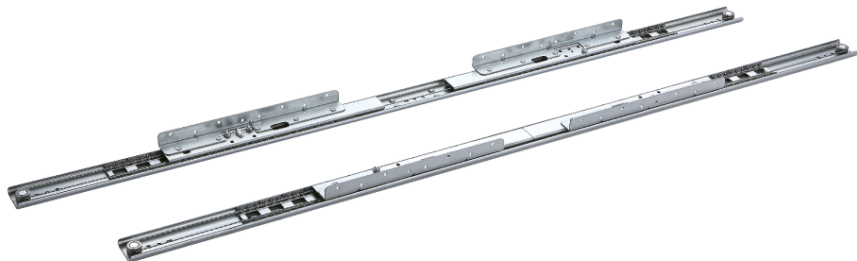

A主轨长度(mm) A Track Length(mm)	B副轨长度(mm) B Track Length(mm)	C中间距离(mm) C Middle distance(mm)	D拉开总长度(mm) D Total length(mm)
800	300	440	1040
850	330	490	1150
900	350	540	1240
950	350	590	1290
1000	400	640	1440
1100	400	740	1540
1200	450	840	1740
1300	500	940	1930
1400	550	1040	2140
1500	600	1140	2340

ADL 餐台轨系列

餐台钢珠滑轨 48MM DINING TABLE SLIDE WITH LIFTING BOX



ADL4802B

980

ADL-4804-S-1-TB-4-ZN--↓--L
1400

ADL4802

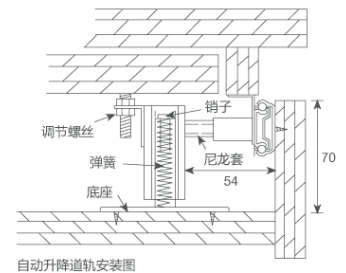

自动升降导轨安装图

ADL4802 / ADL4802B H型自动升降导轨

承重能力:60kg

材料:2mm冷板、2mm镀锌板

表面处理:电镀锌层、电泳

颜色:白色

包装:4套/箱(不含螺丝)

Load rating:60kg

Material:2mm cold-roll sheet / 2mm zinc plated sheet

Finish:Clear zinc plated / electrophoresis

Color:White

Package:4 set / carton(without screw)

导轨总长(mm) Guide rail length	升降架长度(mm) Lifting frame length	升降宽度(mm) Lifting width(mm)	升降高度(mm) Lifting height(mm)
980	610	300	20-30
1100	610	300	20-30
1130	660	350	20-30
1200	660	350	20-30
1300	710	400	20-30
1400	760	450	20-30

48MM KITCHEN SPRING LIFTING DINING TABLE SLIDE



带气杆

ADL-4800-S-1-TB-4-ZN-524-B

ADL48 弹簧导轨

材料:2mm冷板、2mm镀锌板

表面处理:电镀锌层、电泳

颜色:白色

包装:10套/箱(不含螺丝)

Material:2mm cold-roll sheet / 2mm zinc plated sheet

Finish:Clear zinc plated / electrophoresis

Color:White

Package:10 set / carton(without screw)



不带气杆

A主轨长度(mm) A Track Length(mm)	B副轨长度(mm) B Track Length(mm)	C中间距离(mm) C Middle distance(mm)	D拉开总长度(mm) D Total length(mm)
420	260	266	526

餐台轨系列
DINING TABLE SLIDE SERIES

ADL 餐台轨系列

餐台钢珠滑轨 48MM DINING TABLE SLIDE



餐台轨系列
DINING TABLE SLIDE SERIES

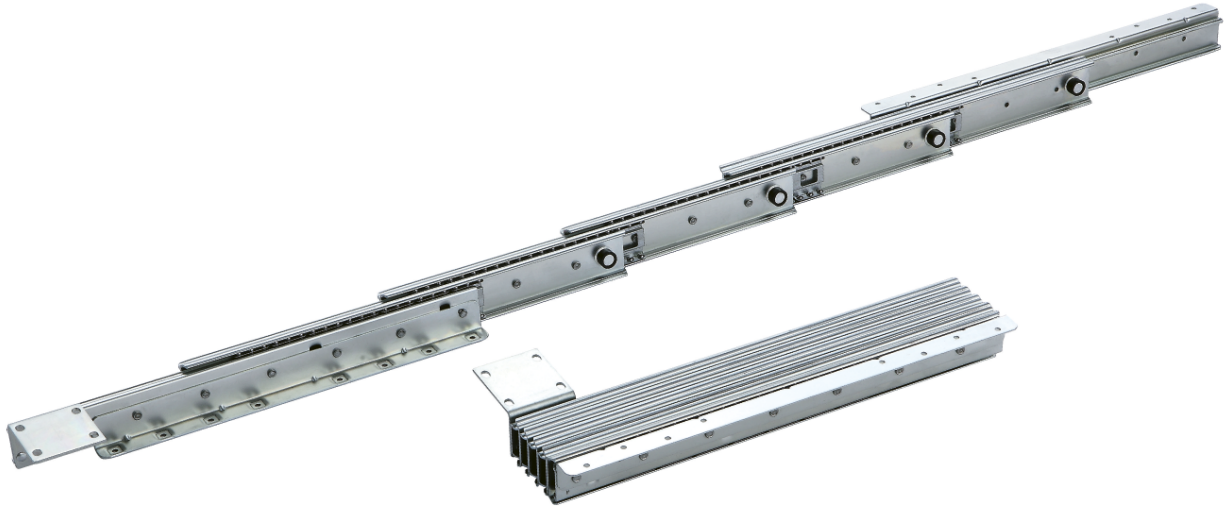

1350

ADL-4803D-S-1-TB-4-ZN- - - - B

2000

ADL4803 多节导轨(带角码)

承重能力:60kg

材料:2mm冷板、2mm镀锌板

表面处理:电镀锌层、电泳

颜色:白色

包装:4套/箱(不含螺丝)

Load rating:60kg

Material:2mm cold-roll sheet / 2mm zinc plated sheet

Finish:Clear zinc plated / electrophoresis

Color:White

Package:4 set / carton(without screw)

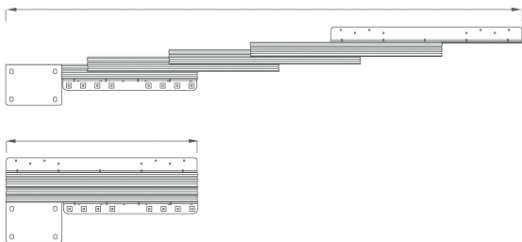

A主轨长度(mm) A Track Length(mm)	B副轨长度(mm) B Track Length(mm)	C道轨节数 C Slide fold	D拉开总长度(mm) D Total length(mm)
300	300	6	1350
400	400	4	1550
400	400	6	1750
450	450	6	1950
450	450	4	1650
450	450	6	2000

ADL 餐台轨系列

餐台钢珠滑轨 48MM DINING TABLE SLIDE



餐台轨系列
DINING TABLE SLIDE SERIES

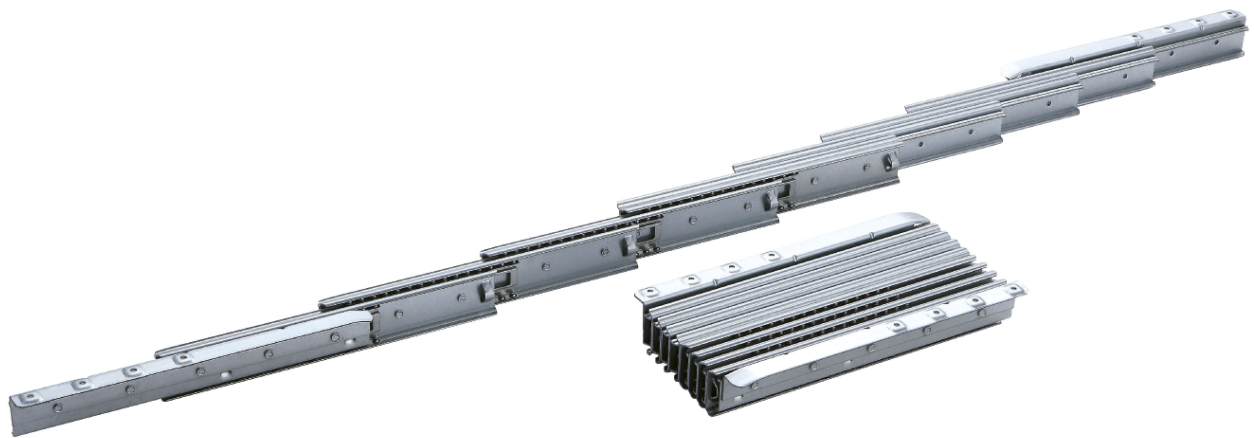

1350

ADL-4803E-S-1-TB-4-ZN--↓--B

2000

ADL4803 多节导轨(不带角码)

承重能力:60kg

材料:2mm冷板、2mm镀锌板

表面处理:电镀锌层、电泳

颜色:白色

包装:4套/箱(不含螺丝)

Load rating:60kg

Material:2mm cold-roll sheet / 2mm zinc plated sheet

Finish:Clear zinc plated / electrophoresis

Color:White

Package:4 set / carton(without screw)

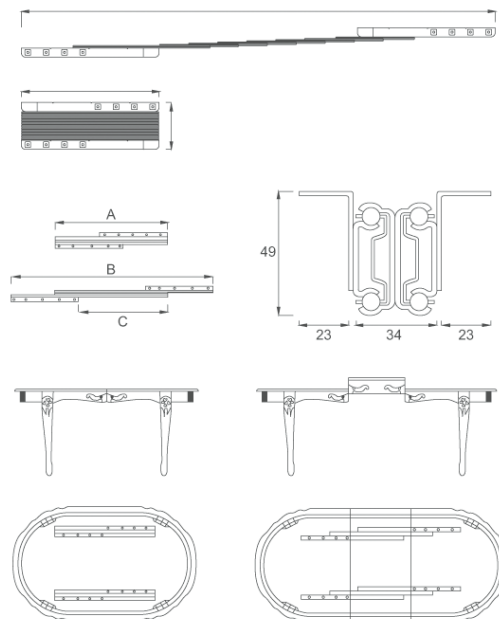

如果特殊规格, 可按客户要求订做。

A 主轨长度(mm) A Track Length(mm)	B 副轨长度(mm) B Track Length(mm)	C 中间距离(mm) C Middle distance(mm)	D 拉开总长度(mm) D Total length(mm)